

Brick: Towards a Unified Metadata Schema For Buildings

<http://brickschema.org/>

A Vision for “Smart Buildings”

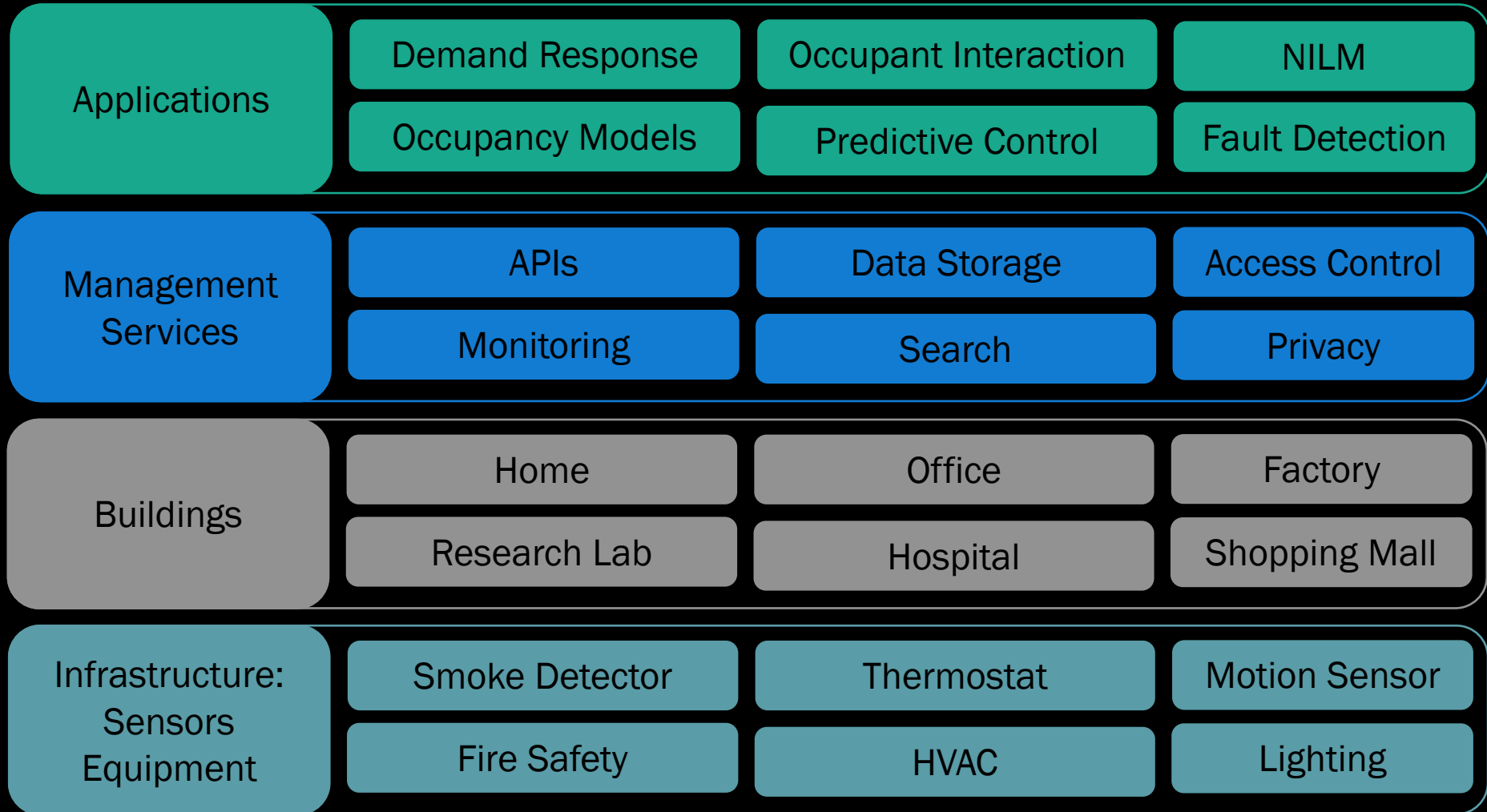

Data From Buildings Faces Significant Challenges in Integration

➤ Apps need to understand building metadata

- Location of sensors and equipment
- How equipment connect with each other
- Configuration parameters of control systems

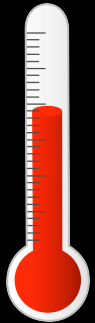

➤ Temperature sensor as an example

- What? -> air, water
- Where? -> room, exhaust, refrigerator
- How is it used? -> control system, fault

➤ But metadata not consistent or machine readable

- E.g. “Temperature” -> “Temp”, “Temporary” -> “Temp”

➤ Metadata varies with building, vendor, type of system

Metadata For An Existing Building

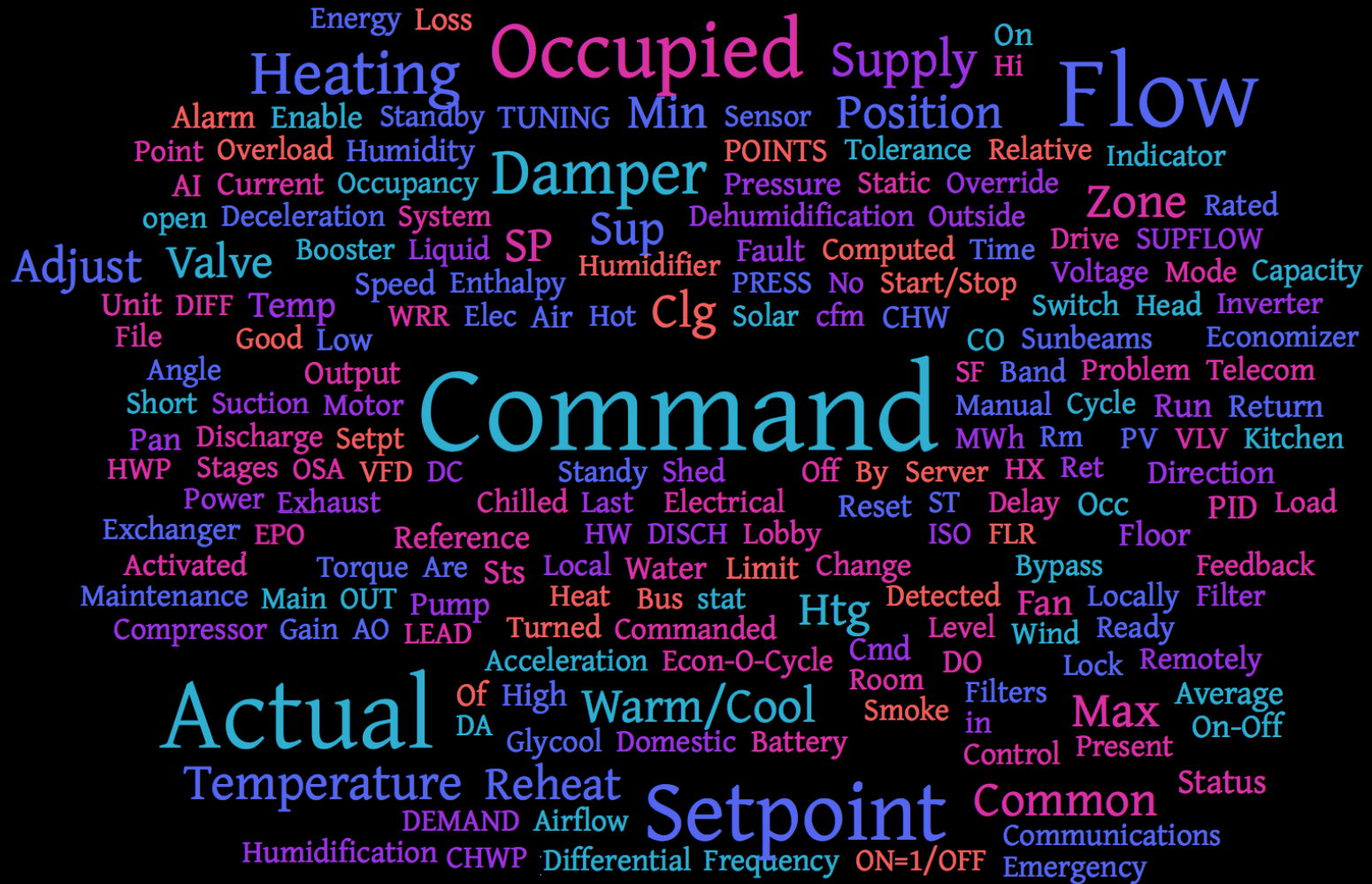

Source: EBU3B building at UCSD, built in 2004. Word cloud limited to 200 most frequent words

We Need a Metadata Schema

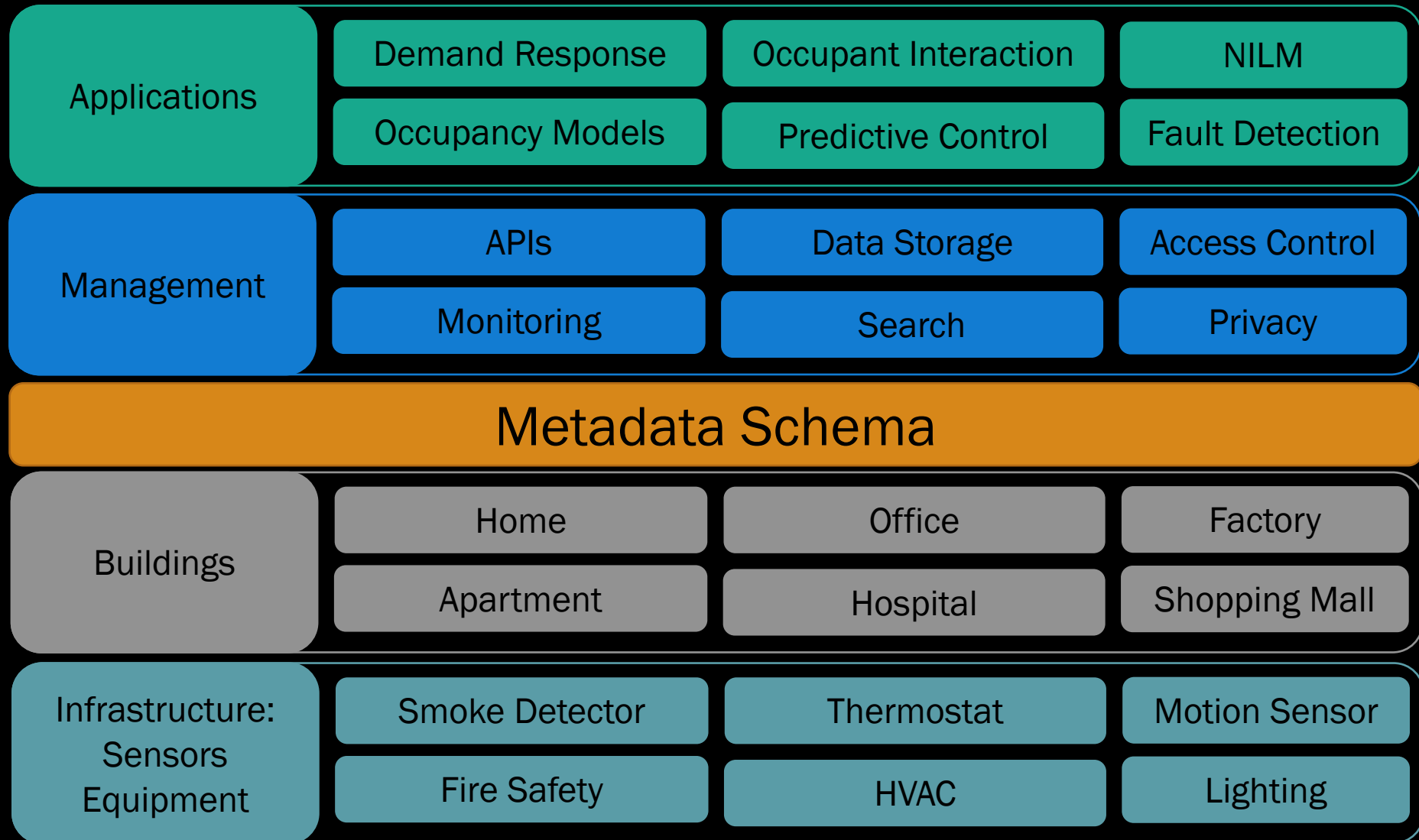

Existing Schema Are Inadequate

BIM/IFC

Domain

Construction

Coverage

Architecture,
Mechanical,
Electrical Design

Data Model

EXPRESS

Limitation

Lack of sensors,
equipment

Existing Schema Are Inadequate

	BIM/IFC	SAREF, SSN
Domain	Construction	Smart Appliances, Sensor Networks
Coverage	Architecture, Mechanical, Electrical Design	Location, Appliance, Sensors
Data Model	EXPRESS	Semantic Ontology
Limitation	Lack of sensors, equipment	Limited vocabulary

Existing Schema Are Inadequate

	BIM/IFC	SAREF, SSN	Haystack
Domain	Construction	Smart Appliances, Sensor Networks	Building Management
Coverage	Architecture, Mechanical, Electrical Design	Location, Appliance, Sensors	HVAC, Lighting, Weather, Sensors, Points
Data Model	EXPRESS	Semantic Ontology	Tags
Limitation	Lack of sensors, equipment	Limited vocabulary	Inadequate tooling, limited relationships

Existing Schema Are Inadequate

Coverage and Expressiveness in Existing Schema

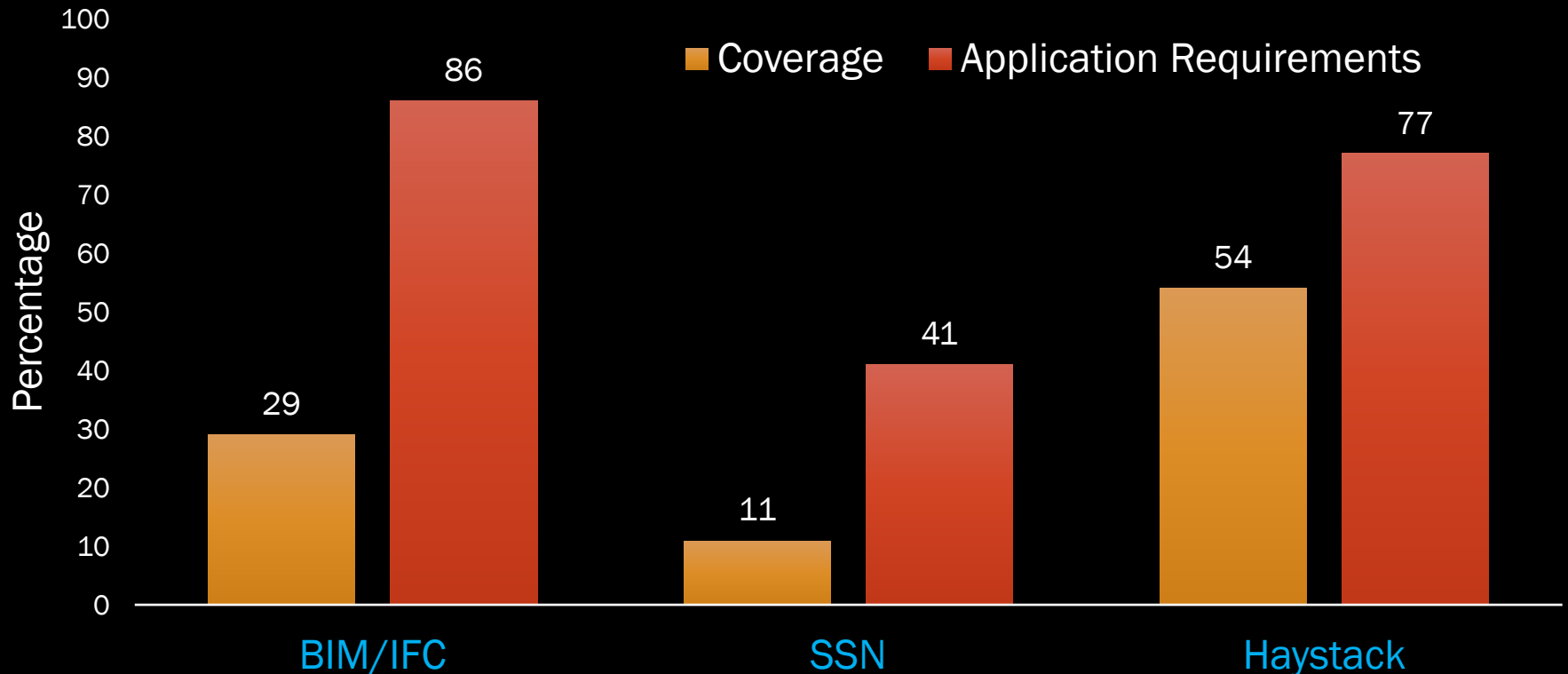

Bhattacharya, Arka, Joern Ploennigs, and David Culler. "Short Paper: Analyzing Metadata Schemas for Buildings: The Good, the Bad, and the Ugly." *BuildSys*, 2015.

Collaborative Solution to a Common Problem

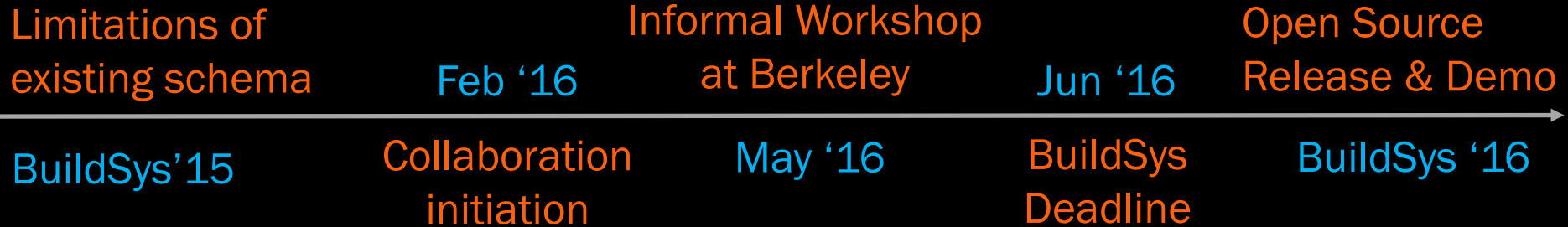



Bharathan Balaji, UCLA



Arka Bhattacharya, UC Berkeley



Gabriel Fierro, UC Berkeley



Jingkun Gao, CMU

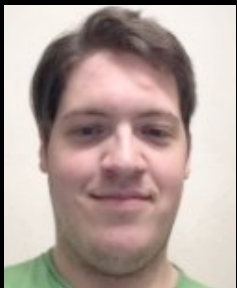

Joshua Gluck, CMU



Dezhi Hong, UVA

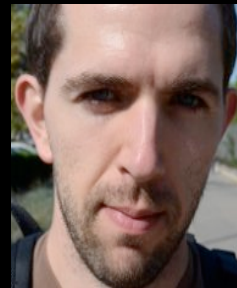

Aslak Johansen, SDU



Jason Koh, UCSD



Joern Ploennigs, IBM



Yuvraj Agarwal, CMU



Mario Berges, CMU



David Culler, UC Berkeley



Rajesh Gupta, UCSD



Mikkel Kjaergaard, SDU



Mani Srivastava, UCLA



Kamin Whitehouse, UVA

UC San Diego

Berkeley
UNIVERSITY OF CALIFORNIA



**Carnegie
Mellon
University**

SDU 

UCLA

IBM®

Brick: Building Metadata Schema

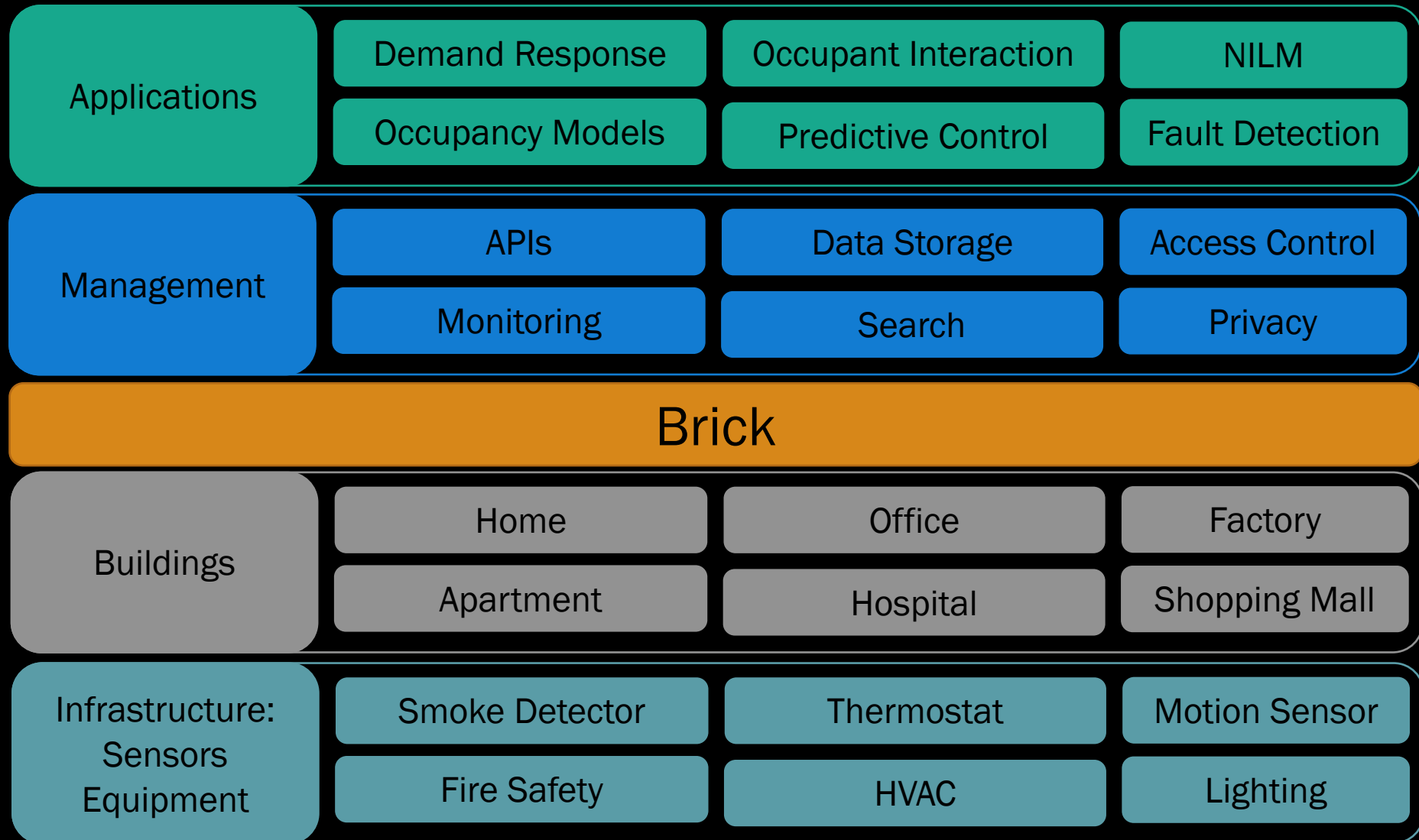

Brick: Building Metadata Schema

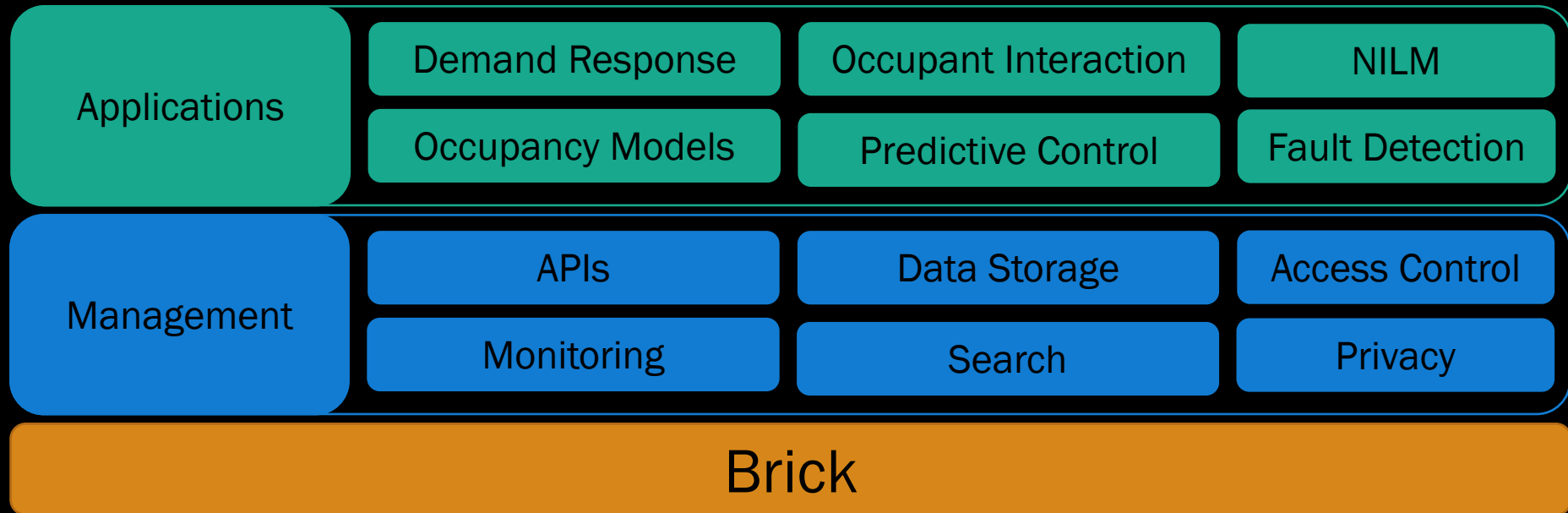

- **Completeness:** Capture all sensors/subsystems
- **Expressiveness:** Capture relationships to run applications
- **Usability:** Easy to understand, easy to map buildings

Outline

- Why do we need Brick?
- Brick
 - Basics
 - Development
 - Results
- Moving forward

Outline

- Why do we need Brick?
- Brick
 - Basics
 - Development
 - Results
- Moving forward

Brick is a Graph of Building Entities

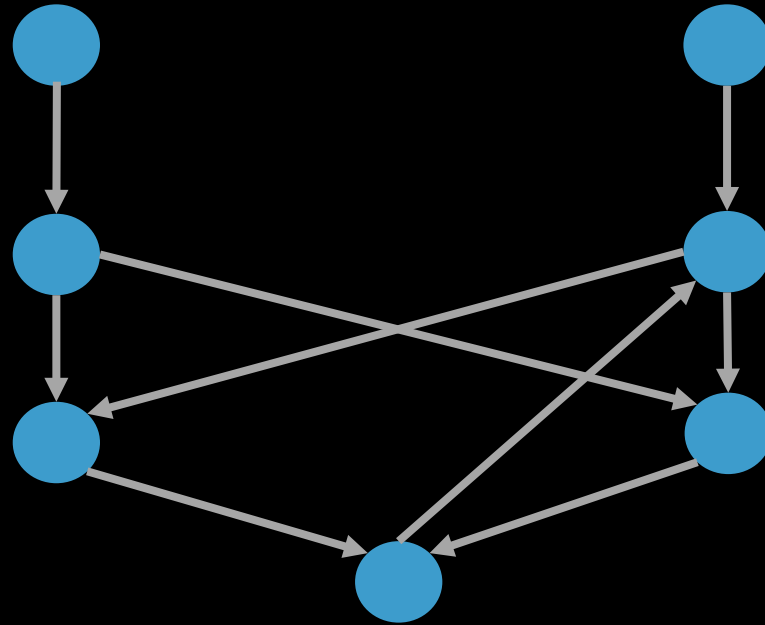

What Does Brick Contain?

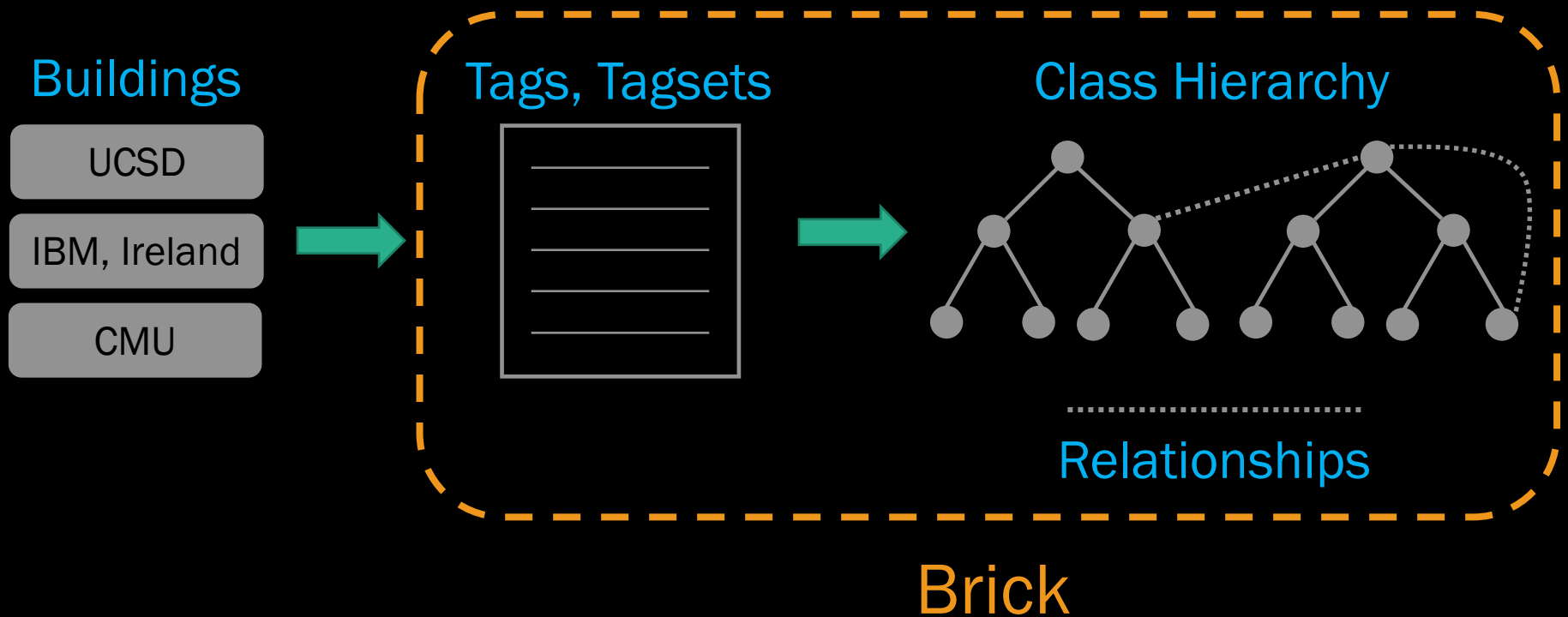

An Example "Model" Building

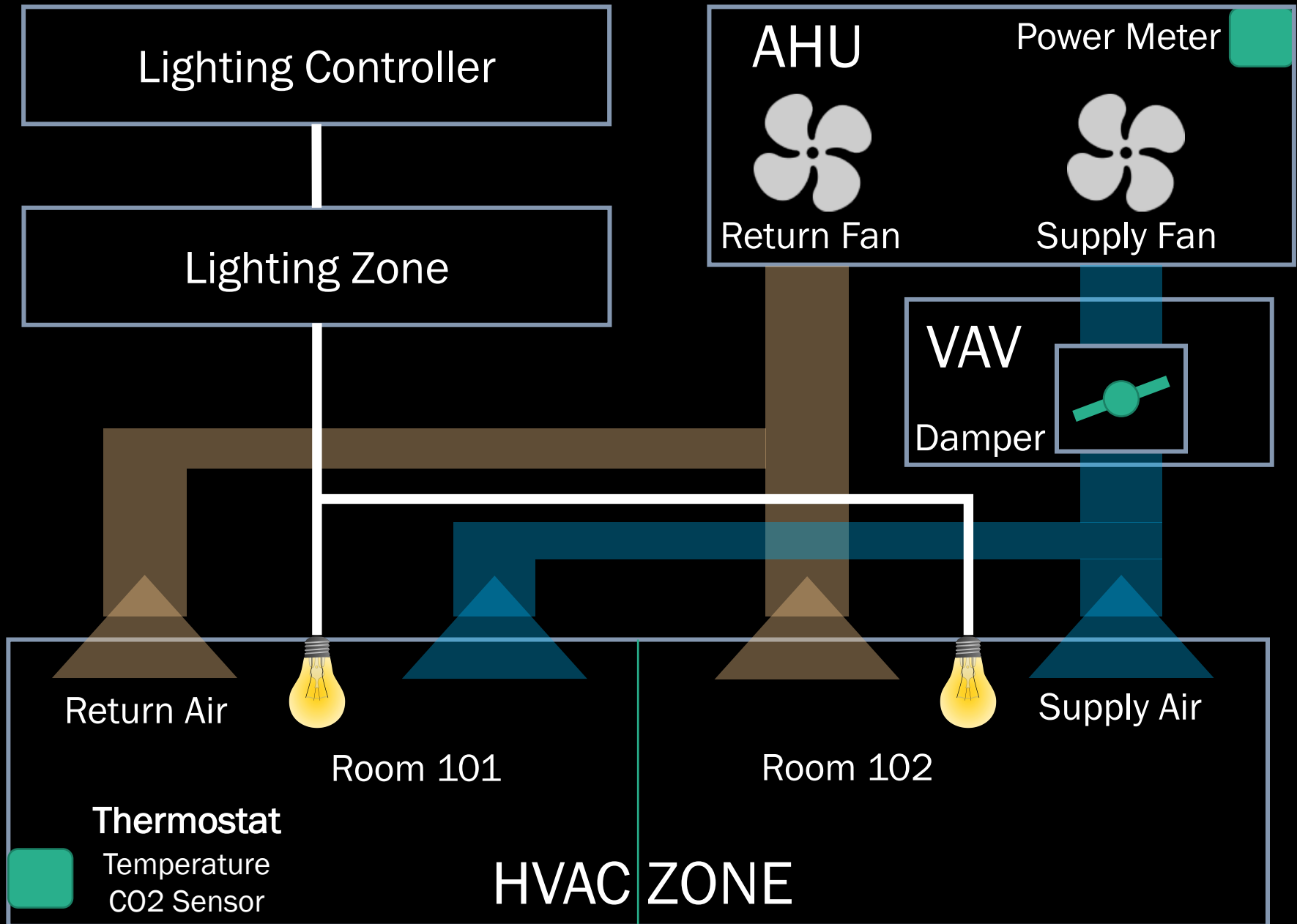

Brick is a Graph of Building Entities

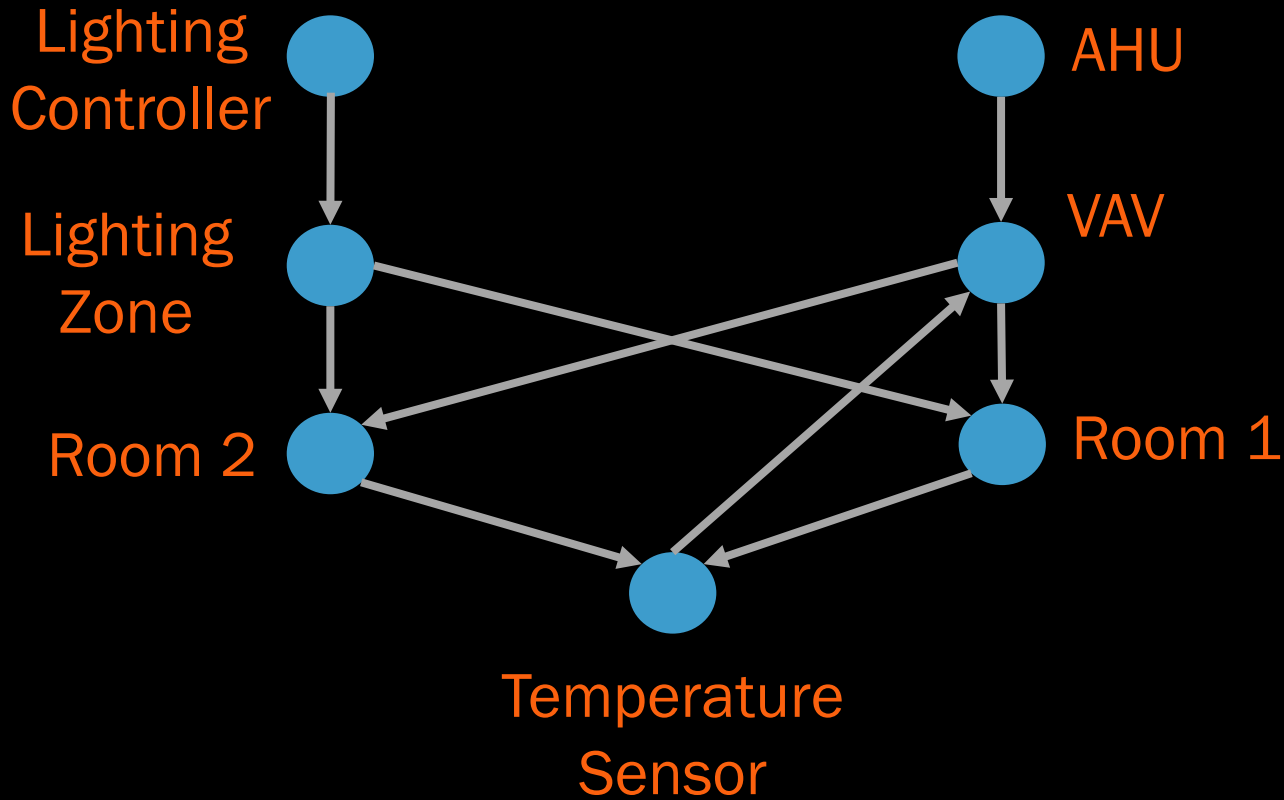

- We choose to model this graph using ontologies
 - Alternatives: Verilog, IFC

Tagsets: Brick Entities

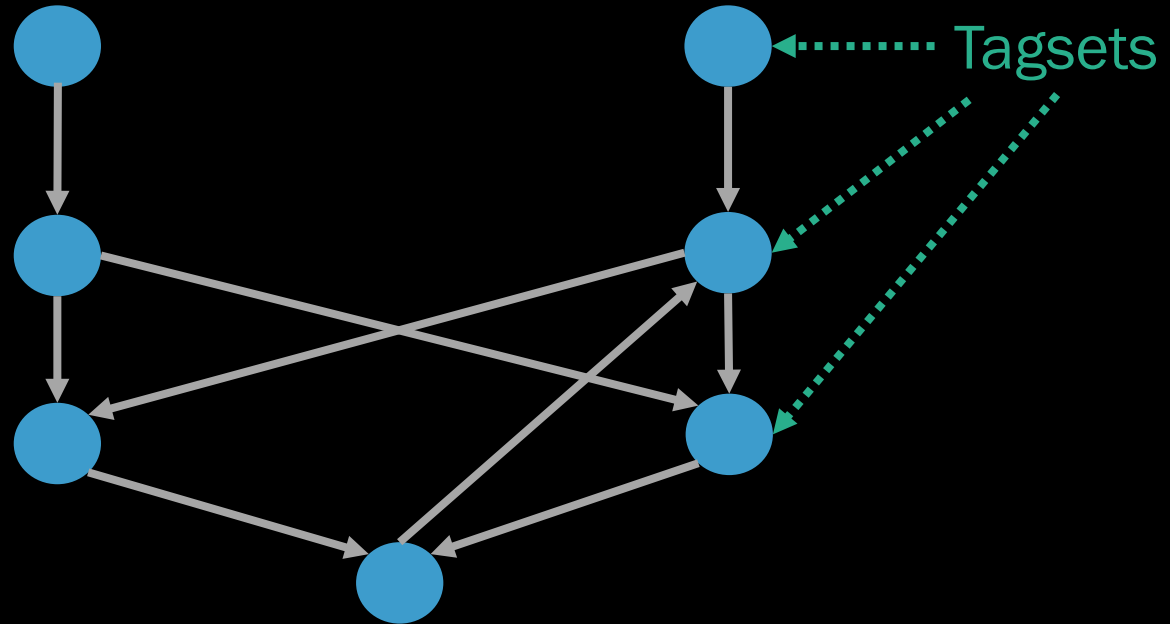

Tagsets and Tags

➤ Tagsets: Building entities described in Brick

- “Zone Temperature Sensor”
- “Zone CO2 Sensor”
- “Room”
- “Air Handler Unit” (also called “AHU”)

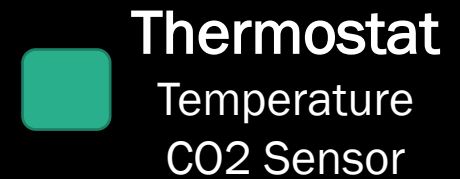

➤ Tags: Decomposition of tagsets

- “Zone Temperature Sensor” -> “Zone” “Temperature” “Sensor”

➤ Tags facilitate annotation and keyword search

➤ Tagsets facilitate semantic modeling

Tagsets are Organized in a Hierarchy

➤ Location

- Building
- Room
 - Conference Room
- HVAC Zone
- Lighting Zone
- ...

➤ Equipment

- Fire Safety System
- HVAC
 - AHU
 - Fan
 - Supply Fan
 - Thermostat
- ...

➤ Point

- Alarm
- Command
 - Damper Command
- Sensor
 - Temperature Sensor
- Setpoint
 - Temperature Setpoint
- ...

Relationships Link Tagsets

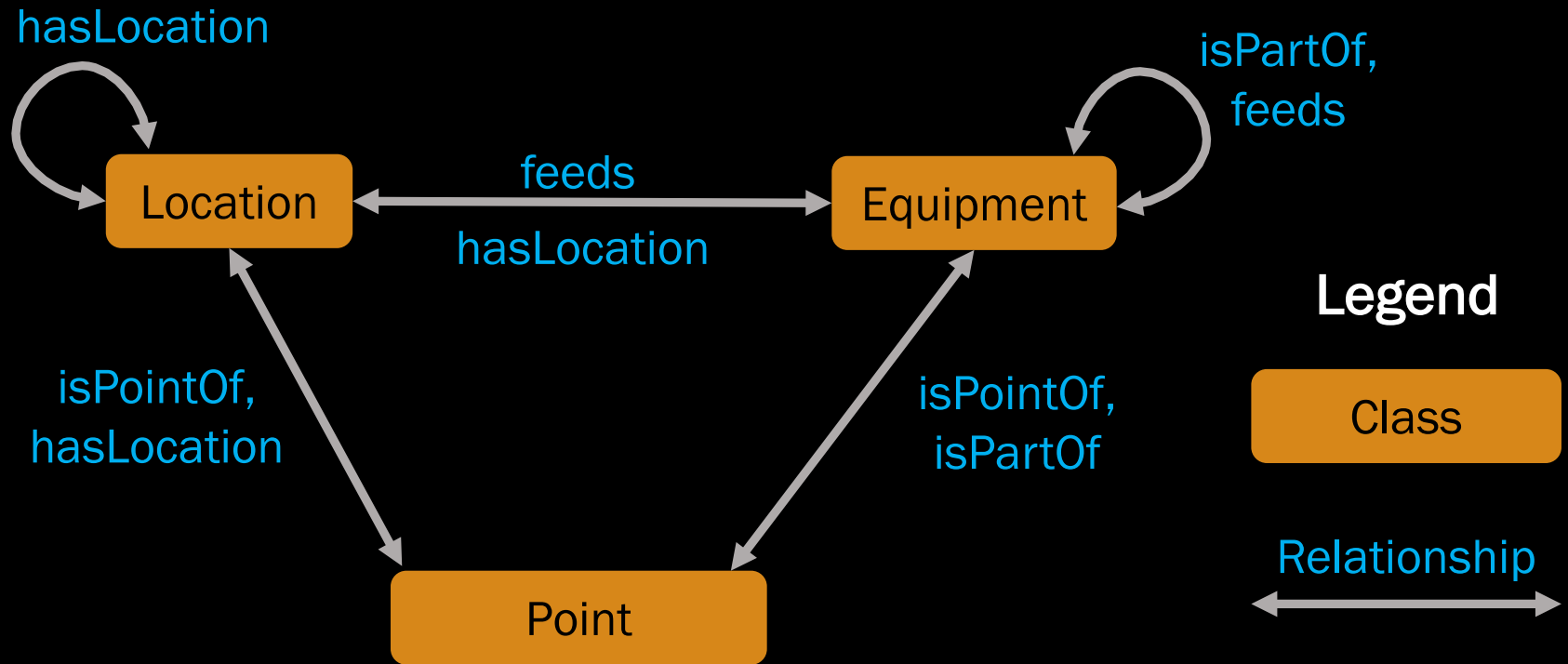

Essential to capture linkages between entities

Relationships in Example Building

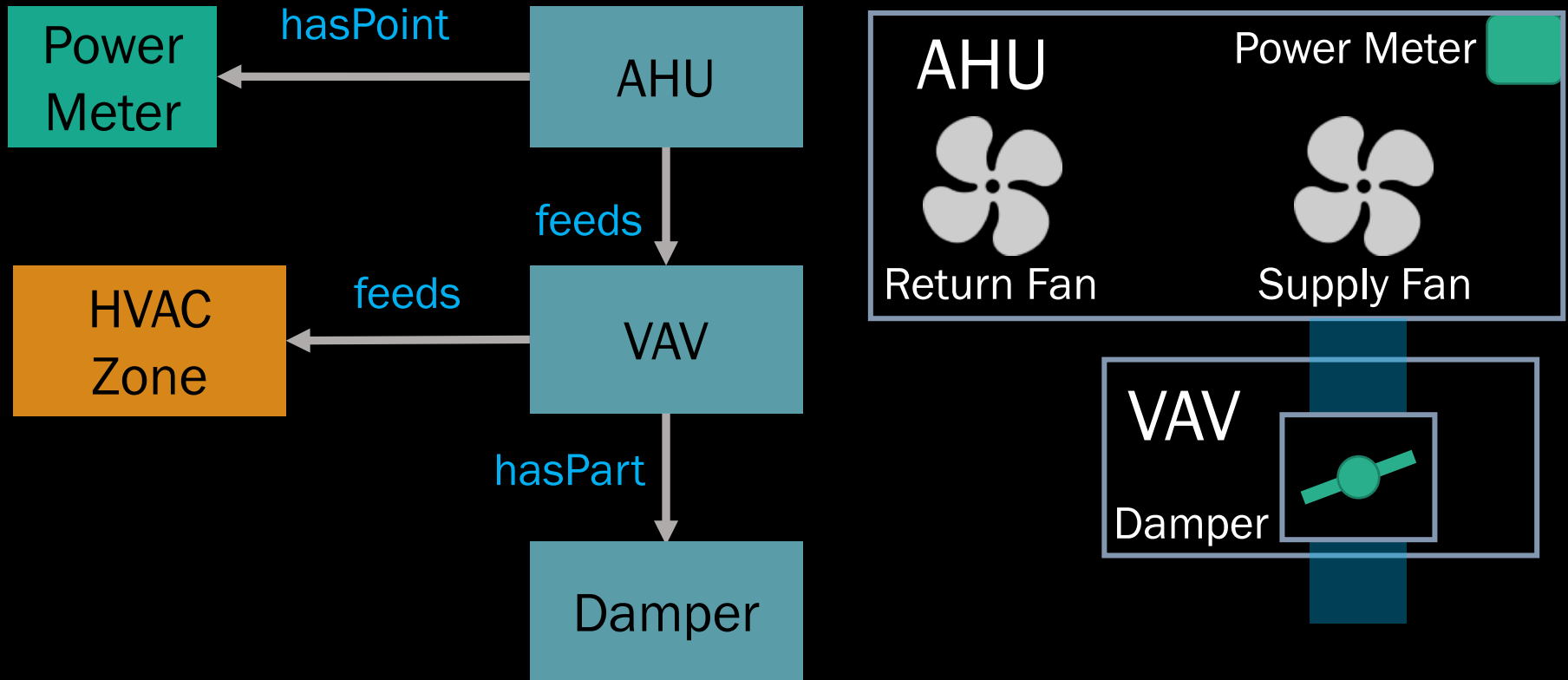

- Designed to capture essential aspects in BMS
- Restrictions to avoid misuse: “hasLocation” limited to Location tagsets

Relationships in Example Building

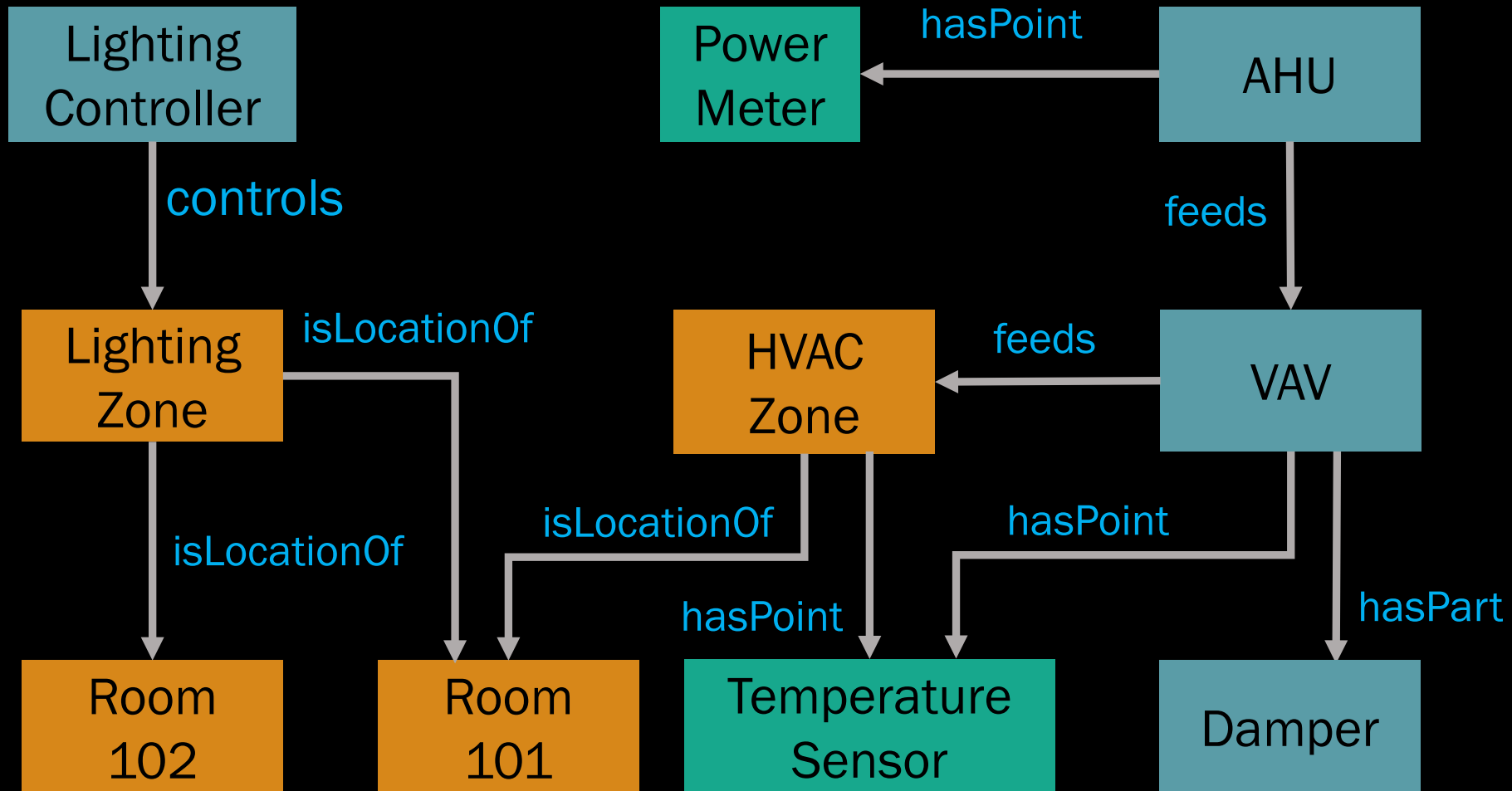

Legend

Location

Equipment

Point

Relationship

Function Blocks

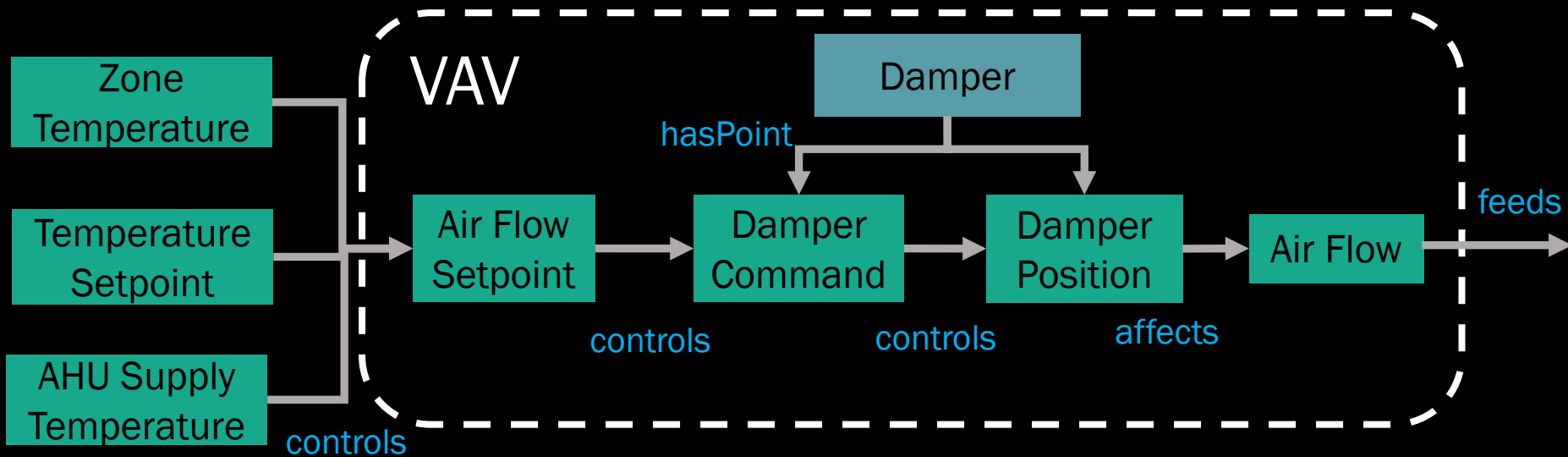
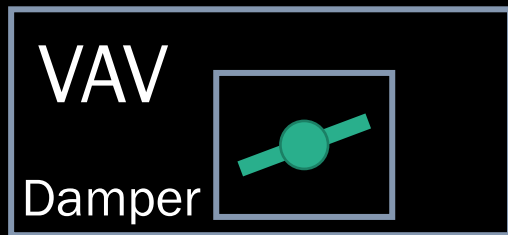

- Enables modularity, encapsulation, reusability
- Library of function blocks to ease development

Machine Readable & Queryable

➤ Triples as data format

- subject predicate object
- Every entity is a URL
brick: <<http://buildsys.org/ontologies/Brick#>>
- example:Berg_Hall rdf:type brick:Room
example:Light hasLocation example:Berg_Hall

➤ SPARQL for querying

- Pattern matches across the graph
- SELECT ?temp WHERE {
 ?temp rdf:type brick:Temperature_Sensor
}

Outline

➤ Why do we need Brick?

➤ Brick

- Basics

- **Development**

- Results

➤ Moving forward

Empirical Methodology

Six Buildings

UCSD

UC Berkeley

SDU

UVA

CMU

IBM, Ireland

17700 points, 630000 sqft.

Eight Representative Applications

Model Predictive
Controls

Occupancy
Modeling

Demand
Response

Energy
Apportionment

Participatory
Feedback

Fault Detection

Web
Displays

NILM

Iterative Development Process

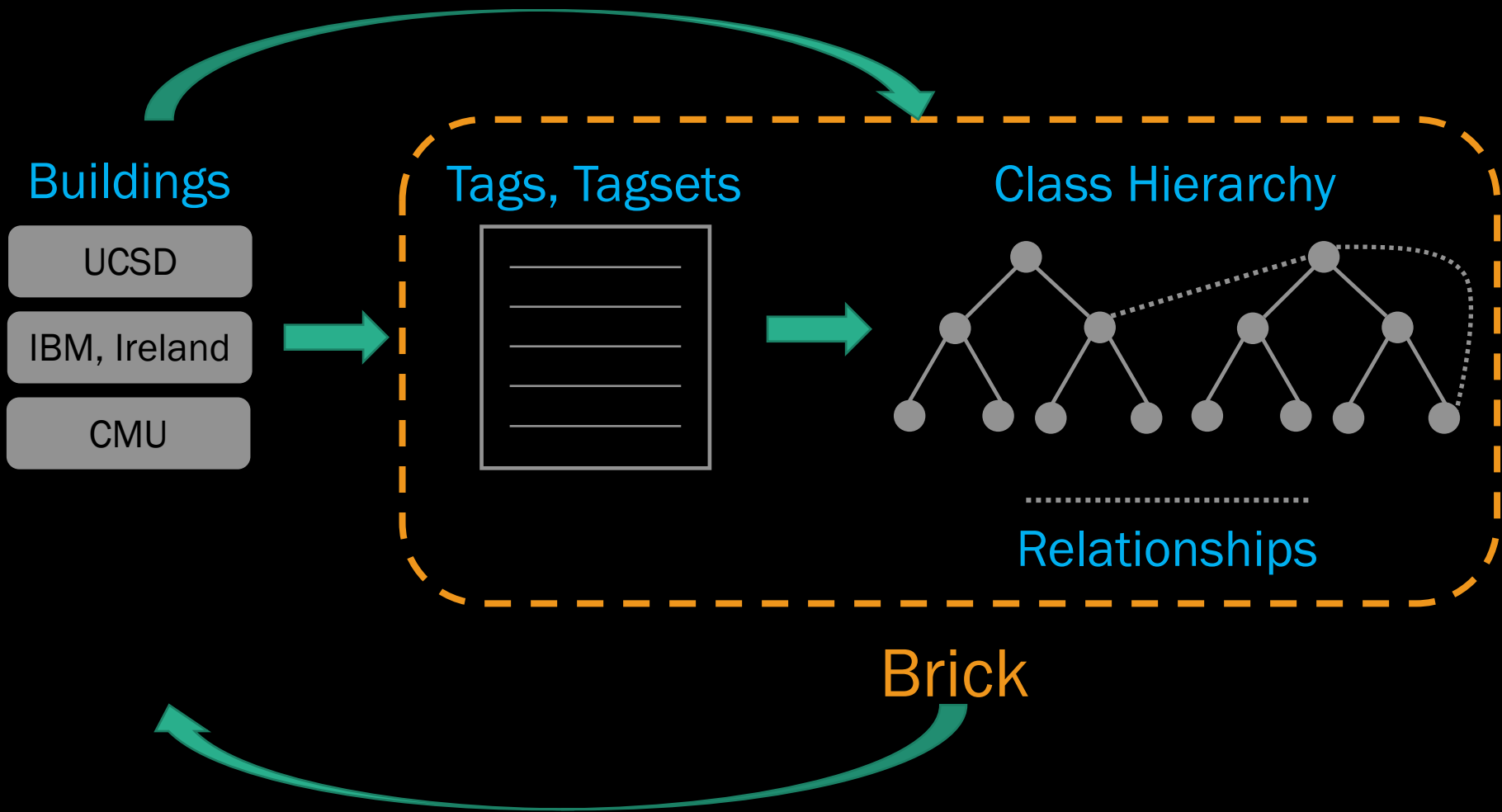

Iterative Development Process

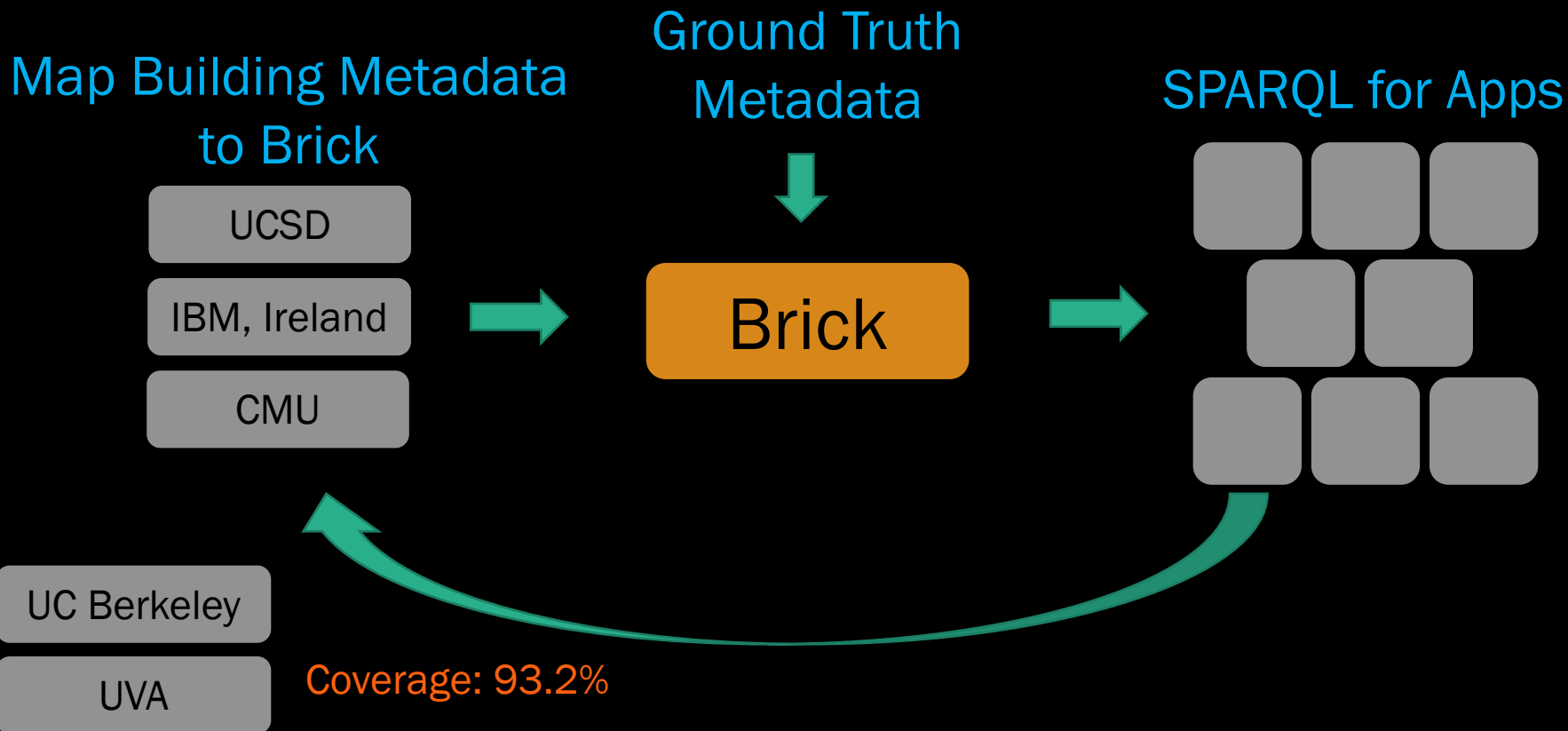

Outline

➤ Why do we need Brick?

➤ Brick

- Basics
- Development
- Results

➤ Moving forward

Coverage Across Buildings

Building	UCSD	CMU	IBM	UVA	Berkeley	SDU
Coverage	96%	99%	99%	98.5%	98.7%	98.8%

App Query Matches for Buildings

	UCSD	SDU	CMU	IBM	UVA	Berkeley
Occupancy	✓	✓	✓	✓	✓	✓
Energy Apportionment	✗	✓	✗	✓	✓	✗
Web Displays	✓	✓	✓	✓	✓	✓
MPC	✓	✓	✓	✓	✓	✓
Participatory Feedback	✗	✓	✗	✓	✗	✗
Fault Detection	✓	✓	✓	✓	✗	✓
NILM	✓	✓	✗	✓	✗	✗
Demand Response	✓	✓	✓	✓	✓	✓

Live Demo

Brick vs Haystack

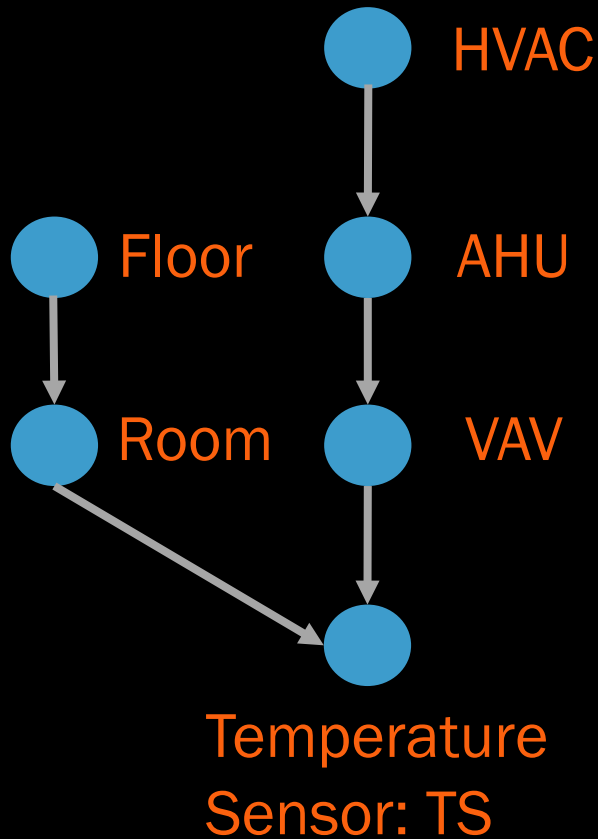

Haystack

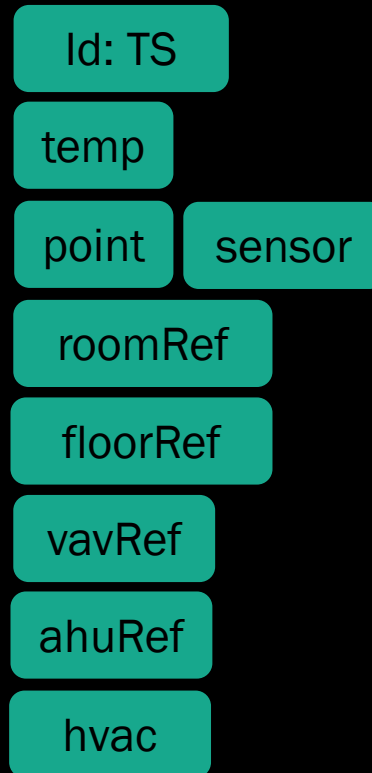

Brick

- TS is a Temperature Sensor
- TS hasLocation Room
- TS isPointOf VAV

Brick vs Haystack

Brick

Haystack

Brick vs Haystack

	Brick	Haystack
Reference Implementation	6 buildings, 8 applications	None

Brick vs Haystack

	Brick	Haystack
Reference Implementation	6 buildings, 8 applications	None
Relationships	Captures relationships within and across subsystems	Can link entities, but does not classify relationships

Brick vs Haystack

	Brick	Haystack
Reference Implementation	6 buildings, 8 applications	None
Relationships	Captures relationships within and across subsystems	Can link entities, but does not classify relationships
Querying	SPARQL queries that traverse Brick graph	Restrictive query, cannot traverse relationships

Brick vs Haystack

	Brick	Haystack
Reference Implementation	6 buildings, 8 applications	None
Relationships	Captures relationships within and across subsystems	Can link entities, but does not classify relationships
Querying	SPARQL queries that traverse Brick graph	Restrictive query, cannot traverse relationships
Encapsulation	Functional blocks encapsulate complex subsystems	No modularity

Outline

- Why do we need Brick?
- Brick
 - Basics
 - Development
 - Results
- Moving forward

Lessons Learned

- Mapping buildings to Brick
 - Semi-automated mapping: 5 papers in BuildSys 2015
- New types of building and equipment
 - Update building tagsets
 - An unknown sensor can be referred to as “Sensor”
- Separation of application from building infrastructure
 - Application specific terms should not be part of Brick

Moving Forward: Call to Action!

- Open Sourced with BSD license
 - <http://brickschema.org/>
- Sustained improvements, extensions:
 - Comments, issue tracking, pull requests on github
- Integrate with building management systems
 - We have an initial integration with BuildingDepot
- Compatibility with IFC
 - Exploit IFC “adapters” to convert CAD specs to Brick
- Brick in Practice
 - Usability testing, performance evaluation, tool-chain support

Thank You!

Visit our Demo!



Bharathan Balaji



Arka Bhattacharya



Gabriel Fierro

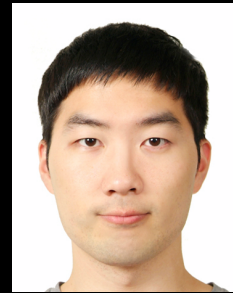

Jason Koh



Yuvraj Agarwal



David Culler



Mikkel Kjaergaard



Mario Berges



Kamin Whitehouse

Authors who are at BuildSys

<http://brickschema.org/>

Image credit: clipartpanda.com, school-pass.com, clker.com